

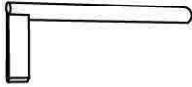





**LISTADO DE PIEZAS
COMPOSANTS
PARTS LIST**

1		1 PC	2		4 PCS			

**HERRAJES
QUINCALLERIE
HARDWARE**

A	 5MM	1 PC	C	 5/16"(BLK)	8 PCS	D	 5/16"(BLK)	8 PCS
E	 4MM	1 PC	G	 5/16"(RB)	12 PCS	H	 6*13MM (RB)	12 PCS

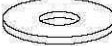
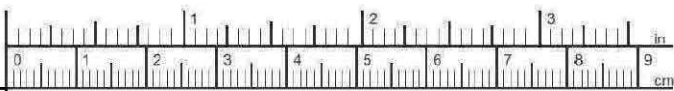

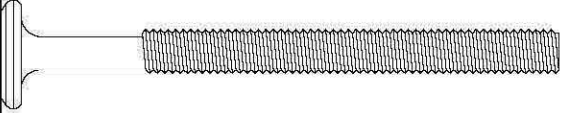
B x8  M8x80 (BLK)

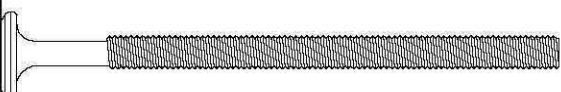
F x12  M6x70 (RB)

I x4 

STEP 1/ ETAPE 1

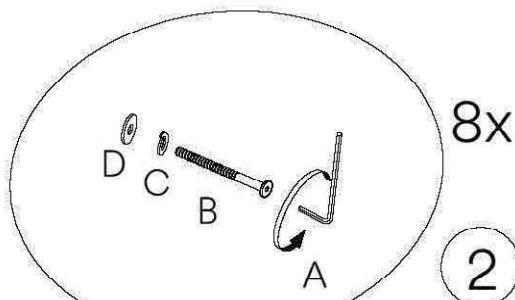

SPANISH :
 En caso de reclamación, por favor, facilitar la información escrita en la etiqueta.

FRENCH :
 En cas de réclamation, merci de transmettre les informations contrnues sur l' étiquette fixée sur le produit.

ENGLISH :
 If you may have whatever complaint, please, let us know the information written on the label.

A		1 PC
B		8 PCS
C		8 PCS
D		8 PCS
I		4 PCS

PI : XXX
 Model: YYY
 XXX

STEP 2/ ETAPE 2

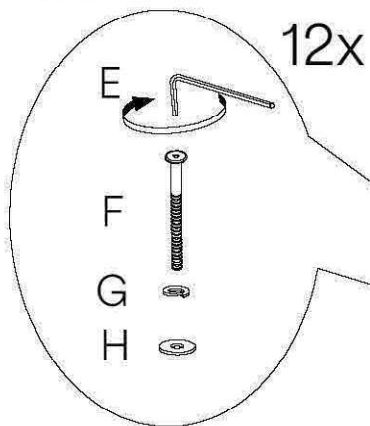

E		1 PC
F		12 PCS
G		12 PCS
H		12 PCS

PRODUIT MONTÉ

